

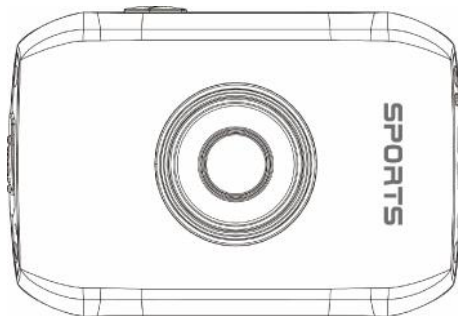

USER MANUAL



CHD528

Mounting Accessories



Waterproof Case



Handlebar
Seatpost
Mount



Shield



Helmet Mount



Car Charger



Helmet Belt



Suction Cup Mount

Quick User Guide

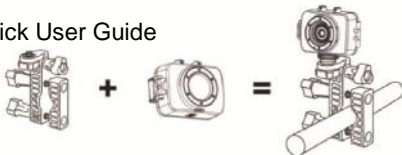

HELMET EDITION



CAR DRIVING RECORDER EDITION



ANNOUNCEMENTS

Please read the Announcements carefully before using this video camera for proper and safe operation, so as to bring its optimum performance into play and extend its service life.

- ◆ Do not expose the video camera to sunshine directly, nor point its lens to sunlight. Otherwise, the image sensor of the video camera may be damaged.
- ◆ Take good care of the video camera and prevent water or sand particles from entering the video camera when it is used on the beach or water, because water, sand particles, dust or component containing salt may damage the video camera.
- ◆ Keep the video camera contaminated free of dust and chemical materials. Place it in a cool, dry and well ventilated place. Do not place the video camera in a high temperature, moist or dusty place.
- ◆ Please check if the video camera can operate normally before use.
- ◆ If dirt or stain is accumulated on the video camera or on its lens, use soft, clean and dry rag to wipe it away gently. If the video camera or its lens is stained with sand particles, blow them away gently. Do not use cloth to wipe arbitrarily. Otherwise, it may scratch the surface of video camera or its lens.
- ◆ If it is required to clean camera surface, firstly blow away the sand dust accumulated on this surface, and then wipe the camera gently with rag or tissue applicable to optical equipments. Please use the cleaning

agent of video camera for wiping if necessary. Do not use organic solvent to clean the video camera.

- ◆ Do not touch the lens surface with fingers.
- ◆ Please back up the data if the memory card inside this video camera is used for the first time.
- ◆ The externally installed memory-cards are manufactured from precise electronic components. Data may be lost or damaged under the following circumstances:
 1. Improper use of the memory card.
 2. The memory card is bent, dropped or collided.
 3. Place it under high temperature or moist environment or expose to sunshine directly.
 4. Electrostatic or electromagnetic field exists around the memory card.
 5. This memory card is taken out or power supply is interrupted when this video camera or computer is connected to the memory card (i.e. during reading, writing and formatting).
 6. Touch the metal contact surface of the memory card with fingers or metal materials.

WATERPROOF CASE USING NOTICE

- ◆ Before sealing the waterproof case, keep the camera housing's rubber seal clean, a single hair or grain of sand can cause a leak. You can test by closing the case without inserting the camera. Submerge the case completely in water for about a minute. Remove the case from the water, dry off its exterior with a towel, then open the case. If the entire interior is dry, the case is safe for use under water.
- ◆ Remember to put the Mode Switch in your desired recording position before inserting the camera in the waterproof case. There is no external button for the Mode Switch.
- ◆ After every use in salt water you will need to rinse the outside of the housing with non-salt water and dry. Not doing this can eventually cause corrosion of the hinge pin and salt buildup in the seal, which can cause failure.
- ◆ To clean the seal, rinse in fresh water and shake dry (drying with a cloth may cause lint to compromise the seal). Re-install the seal into the grooves in the backdoor of the housing.

Introduction to Appearance and Keypad

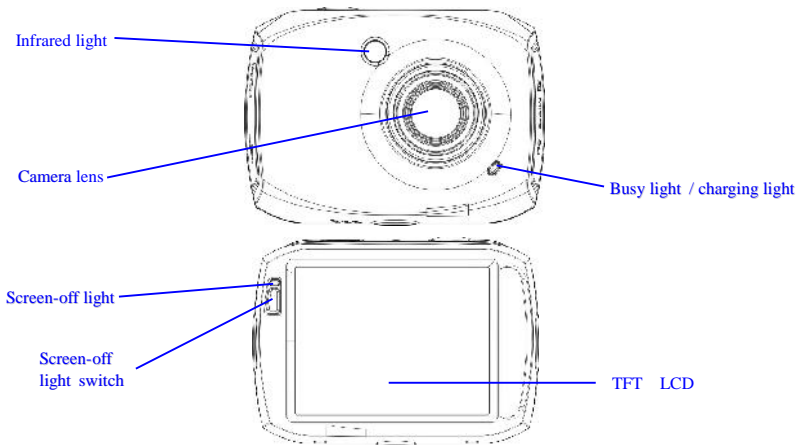

Tripod nut

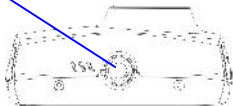

Microphone

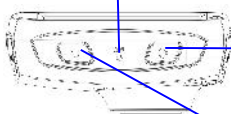

Power key

Shutter Key

MicroSD slot

Reset key

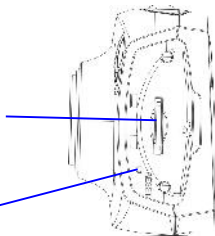

HDMI interface

USB interface

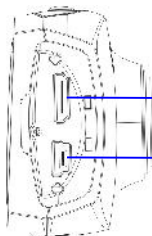

USAGE

1. Charge the built-in lithium battery

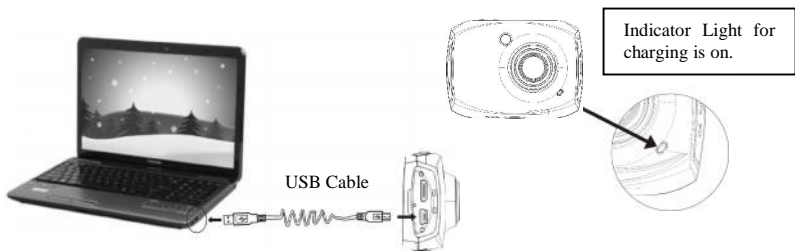

Connect the video camera with computer for charging in the shutdown state. The indicator light for charging is on at this time and will be off after charging. In general, it can be fully charged after 2-4 hours.

2. USE OF MEMORY CARD

1. Push the memory card into the card slot according to the concave lettering beside the slot of memory card till it is completely inserted.
2. To take out the memory card, gently press the end of the memory card inward and it will pop up.



Note: No built-in memory is available in this video camera. Make sure to insert memory card before using.

3. STARTUP/SHUTDOWN

3.1 Startup: Press the POWER button for 3 seconds, the screen is displayed and the camera is on.

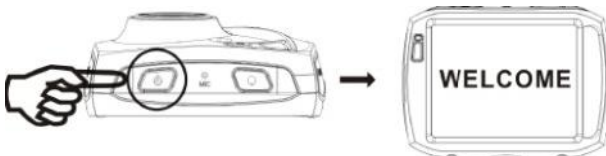

3.2. Shutdown: Press the POWER Key, and the camera will be shut down. .

Automatic shutdown: when the idle time of the video camera reaches the time for automatic shutdown, it will be shut down automatically to save power. The default time of this camera for automatic shutdown is 5 minutes.

3.3. Shutdown in case of power shortage: when the power of the battery is insufficient, the LCD display screen will display the low power icon. Please charge it in time. When indicate light turns red and flickering, the video camera will be shut down automatically.

4. CONVERSION BETWEEN FUNCTION MODES

Three modes are available for this video camera, i.e. picture taking mode, video recording mode and vehicle-mounted mode. Conversion is available via the mode switch after startup.

Picture taking mode: pictures can be taken;

Video recording mode: video can be recorded;

Vehicle-mounted mode: videotape can be recorded.

(one section every 5 minutes)



Video recording mode



Photo mode



Vehicle mode



5. INDICATOR LIGHT

Busy light: when the camera is busy (such as, recording a film, taking photos, automatic off-screen), the busy light will be on.

Charging light: when the light is on for a long time, it prompts the user that the camera is charging.

6. VIDEO RECORDING MODE

When the mode switch is turned to video recording mode, press the shutter button once or click the LCD center once to begin recording under previewing state; press the shutter button once again if you want to stop recording, and the camera will also stop recording, automatically when the memory card is full or the power is insufficient-





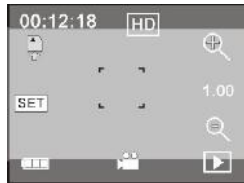

1 **00:12:18:** Timer means that video recording can still last for 12 minutes and 18 seconds.

2  : mode icon, represents that the video camera is in video recording mode.

3  : videoing size, clicks this icon and you can choose 720P/VGA.

4  : means that the memory card is inserted at present.





- 5  : digital zoom icon, click it and enlarge it.
- 6  : digital zoom icon, click and minify it.
- 7  : visual shutter, touch this visible frame for taking photos or recording.
- 8  : battery icon, represents the power status of the battery.
- 9  : represents the status of digital zoom.
- 10  : click this icon to switch to the playback mode.
- 11  : click this icon to set the date and time, finished setting and press Shutter key to confirm.

7 PICTURE TAKING MODE:

1 **0/1234**: Counter, indicating current number of photos taken already /number of photos to be taken.

2  : mode I con, indicating that the camera is in photo taking mode.

3  : video size, click this icon to select the photo resolution.

4  : means that the memory is been inserted at present.

5  : digital zoom icon, click it to enlarge.

6  : digital zoom icon, click it to minify.

7  : visual shutter, touch this visible frame for taking photos or recording.

8  : battery icon, indicates the power status of the battery.

9 **1.00** : represents the status of digital zoom.

10  : click this icon to switch to the playback mode.

11 **SET** : click this icon to set the date and time, finished setting and press Shutter key to confirm.

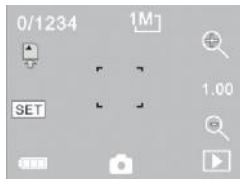



8 VEHICLE-MOUNTED MODE:

1 00:12:18 timer, indicating that the camera can still record for 12 minutes and 18 seconds.

2  : mode icon, representing that the camera is in vehicle-mounted mode.

3  : video size, click this icon to select 720P, VGA.

4  : represents that the memory card has been inserted.

5  : digital zoom icon, click it to enlarge.

6  : digital zoom icon, click it to minify.

7  : visual shutter, touch this visible frame for taking photos or recording.

8  : battery icon, representing the current power status of the battery.

9  : represents the status of digital zoom.

10  : click this icon to switch into the playback mode.









11  : click this icon to set the date and time, finished setting and press Shutter key to confirm.



9 PLAYBACK MODE:

9.1 After starting up and entering the previewing state, click the playback icon () at the lower right corner of the LCD to switch to the playback mode:

Click

- 1  : represents that the current file is an AVI video file.
- 2  : represents that there is one file in the current folder/one file in total.
- 3  : current folder name (such as: I:\DCIM\100MEDIA
I: is the movable disk of the device).
- 4  : Means that clicking can select files frontwards.
- 5  : Means that clicking can select files backwards.
- 6  : Means that clicking can activate to confirm the deletion of the current file picture.
- 7  : Means that clicking can play the current movie clips.
- 8  : Means that clicking can switch back to the previous photo mode (video mode).



9.2 Movie clips playing:



Click  to pause playing, click  to play forward, and click  to play backward.

9.3 File deletion:

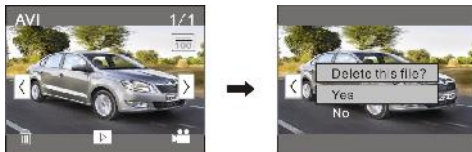

Click YES to delete the current file immediately, or click NO to cancel the request of deletion.

APPLY ON THE PERSONAL COMPUTER

Connect to personal computer

The camera is provided with the plug and play function. Connect the device to the computer with USB line under turning-on state, then it will be switched into the movable hard disk mode.

Icon of movable disk will appear on the window of “my computer”. Photos/videos you have taken are saved in folder I:\DCIM\100MEDIA (I is the movable disk of this device) in the movable disk. Files recorded in vehicle-mounted mode are saved in I:\DCIM\RECORDER.

SAFETY-ENVIRONMENT



Your STOREX product has been laboratory tested; it complies with European guidelines corresponding to the CE labelling in force at the time of its launch.



Your STOREX product's components are traceable; this demonstrates the product's compliance to environmental guidelines (RoHS) in force at the time of its launch.



Once the product has reached the end of its lifespan, don't throw it in a dustbin. Return it to the retailer or bring it to a rubbish heap, to ensure the product is properly disposed of via a waste electrical and electronic equipment (WEEE) channel.

WARRANTY REGISTRATION

In order to facilitate the management of your issue should you contact our support team, we invite you to register your tablet guarantee on our website at the following address: <http://garantie.storex.eu>

For repairing, contact your dealer to repair your tablet under guarantee, or send your request via email to the following address: support@storex.eu

or by phone at:

France: 01 55 85 82 00 (local call charge to Paris)

Spain: 902 110 572 (soporte.es@storex.eu)

Portugal: 707 20 14 20 (apoio.pt@support.eu)

England: (support.uk@storex.eu)

X'TREM 

by  **STOREX**